



JABALÍ PINS



ALFILERES, PINS, EPINGLES, STECKNADDELN, SPILLI, AGULLES, ALFINETTES, KNAPPENALER



ÍNDICE / INDEX

ARTÍCULO / ARTICLE

FAMILIA / FAMILY

PG

	ALFILERES DE ACERO / HARD STEEL PINS	AC	1
	ALFILERES DE HIERRO / MILD STEEL PINS	FE	3
	PORTAPRECIOS / TICKET PINS	PP	4
	MACASARES / LOOSE COVER PINS	MA	4
	ALFILERES CABEZA DE COLORES / COLOURED HEAD PINS	CC	5
	ALFILERES DE SEÑALIZACIÓN/ PUSH PINS	SE	6
	IMPERDIBLES ESPECIALES / SPECIAL SAFETY PINS	IM	7
	MANUALIDADES ESCOLARES / SCHOOL CRAFTS ARTICLES	ES	7
	IMPERDIBLES NIQUELADOS / NICKEL PLATED SAFETY PINS	IM	8
	IMPERDIBLES DORADOS / BRASS SAFETY PINS	IM	9
	IMPERDIBLES NEGROS / BLACK SAFETY PINS	IM	9
	PUAS DE HIERRO / MILD STEEL STEMS	PU	9
	ALFILERES PARA CAMISAS / SHIRT PINS	CA	10
	ALFILERES DE LATÓN / BRASS PINS	LL	11
	ALFILERES ACERO INOXIDABLE / STAINLESS STEEL PINS	AI	12
	ALFILERES CABEZA DE PERA / DIPPED HEAD PINS	AP	12
	CLIPS CAMISEROS / CROSS OVER SHIRT CLIPS	CM	13
	PINZAS DE PLÁSTICO / PLASTIC SHIRT PINS	SA	15
	IMPERDIBLES DE COLORES / COLOURED SAFETY PINS	IM	16



ÍNDICE / INDEX

	ARTÍCULO / ARTICLE	FAMILIA / FAMILY	PG
	IMPERDIBLES DE BEBÉ / NAPPY PINS	IM	17
	IMPERDIBLES PARA FALDA / KILT PINS	IF	17
	DEDALES / THIMBLES	DI	18
	GANCHOS PARA CORTINA / CURTAIN HANGERS	GA	19
	PORTAEMBLEMAS / BADGE PINS	EM	19
	CINTAS MÉTRICAS / TAPE MEASURES	CI	19
	ALFILETEROS / PIN CUSHION	AL	20
	COSTUREROS / SEWING BASKETS	CS	20
	AGUJAS MÁQUINA DE COSER / SEWING MACHINE NEEDLES	MC	21
	ALFILERES PARA DECORACIÓN / SEQUIN PINS	HC	22
	FIGURAS DE POLIESPÁN / STYROFOAM FIGURES	HC	22
	ALFILERES PARA BOLILLOS / LACE PINS	BCL	23
	KITS DISEÑO DE FIGURAS / BEAD FIGURES	KI	24
	ALAMBRE COBRE DE COLORES / COLOURED WIRE	HI	25
	ALFILERES PARA INSECTOS / INSECT PINS	IN	25
	CÁNCAMOS / BRASS EYEBOLT	PE	26
	GANCHOS / EYE PINS	PE	26
	ESPIGAS / HEAD PINS	PE	26
	CLAVOS PARA MARQUETERÍA / BRASS ESCUTCHEON PINS	CL	26



ALFILERES DE ACERO / HARD STEEL PINS

AC

Ideales para costura y confección / For dressmaking and tailoring NIQUELADO / NICKEL PLATED

Ilustración a escala Illustration on scale	REFERENCIA CODE	Nº	LONGITUD LENGTH	DIÁMETRO GAUGE	ENVASE BOX	CÓDIGO CODE
	AAN2665		26 mm (1-1/32")	0,65 mm (0,025 in)	CARTÓN 1 KG CARDBOARD BOX 1 KG 	00
	AAN5060	5E	28 mm (1-1/8")	0,60 mm (0,023 in)		
	AAN5065	5	28 mm (1-1/8")	0,65 mm (0,025 in)	CARTÓN 500 G CARDBOARD BOX 500 G 	01
	AAN3050	6EE	30 mm (1-1/5")	0,50 mm (0,019 in)		
	AAN6060	6E	30 mm (1-1/5")	0,60 mm (0,023 in)	CARTÓN 250 G CARDBOARD BOX 250 G 	02
	AAN6065	6	30 mm (1-1/5")	0,65 mm (0,025 in)		
	AAN7060	7E	32 mm (1-1/4")	0,60 mm (0,023 in)	CARTÓN 100 G CARDBOARD BOX 100 G 	03
	AAN7055	7E	32 mm (1-1/4")	0,55 mm (0,021 in)		
	AAN7065	7	32 mm (1-1/4")	0,65 mm (0,025 in)	EXPOSITOR 20 C/200 U. 	16
	AAN8060	8E	34 mm (1-1/3")	0,60 mm (0,023 in)		
	AAN8065	8	34 mm (1-1/3")	0,65 mm (0,025 in)	EXPOSITOR 20 C/200 U. 	16
	AAN9070	9	36 mm (1,41 in)	0,70 mm (0,027 in)		
	AAN1170	11	40 mm (1,57 in)	0,70 mm (0,027 in)	EXPOSITOR 20 C/200 U. 	16
	AAN4565		45 mm (1-3/4")	0,65 mm (0,025 in)		

PARA IDENTIFICAR UN PRODUCTO CORRECTAMENTE DEBE AÑADIR AL CÓDIGO DEL ARTÍCULO EL CÓDIGO DEL ENVASE.

AAN4565 00

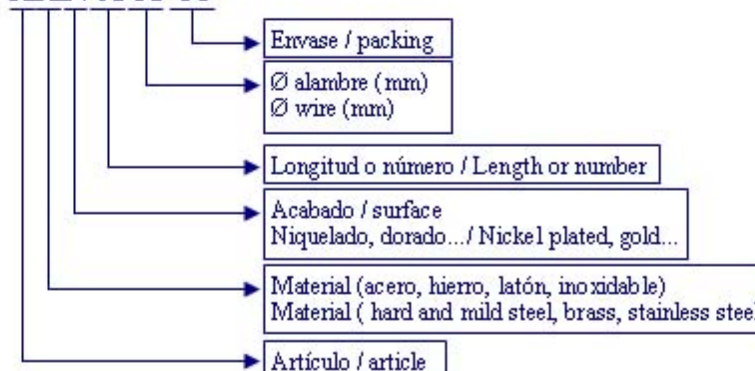

info@folch.com / tel. 34-977826196 / fax 34-977826489

www.alfileres.com

All straight pins are available in 1/2 lb. And 1 lb. boxes



**Easy pick up
plastic box**



ALFILERES DE ACERO / HARD STEEL PINS

AC

Ideales para costura y confección / For dressmaking and tailoring NIQUELADO / NICKEL PLATED

Ilustración a escala Illustration on scale	REFERENCIA CODE	N°	LONGITUD LENGTH	DIÁMETRO GAUGE	ENVASE BOX	CÓDIGO CODE
	AAN2665		26 mm (1-1/32 ")	0,65 mm (0,025 in)	CAJA PLÁSTICO 500 G PLASTIC BOX 500 G	21
	AAN5060	5E	28 mm (1-1/8 ")	0,60 mm (0,023 in)		
	AAN5065	5	28 mm (1-1/8 ")	0,65 mm (0,025 in)		
	AAN3050	6EE	30 mm (1-1/5 ")	0,50 mm (0,019 in)	CAJA PLÁSTICO 250 G 09 sin espuma PLASTIC BOX 250 G 14 con espuma	
	AAN6060	6E	30 mm (1-1/5 ")	0,60 mm (0,023 in)		
	AAN6065	6	30 mm (1-1/5 ")	0,65 mm (0,025 in)		
	AAN7060	7E	32 mm (1-1/4 ")	0,60 mm (0,023 in)		
	AAN7055	7E	32 mm (1-1/4 ")	0,55 mm (0,021 in)	CAJA PLÁSTICO 50 G 08 con espuma PLASTIC BOX 50 G 07 sin espuma	
	AAN7065	7	32 mm (1-1/4 ")	0,65 mm (0,025 in)		
	AAN8060	8E	34 mm (1-1/3 ")	0,60 mm (0,023 in)		
	AAN8065	8	34 mm (1-1/3 ")	0,65 mm (0,025 in)		
	AAN9070	9	36 mm (1,41 in)	0,70 mm (0,027 in)	CAJA PLÁSTICO 50 G 05 CON ASA PLASTIC BOX 50 G WITH HANDLE	
	AAN1170	11	40 mm (1,57 in)	0,70 mm (0,027 in)		
	AAN4565		45 mm (1-3/4 ")	0,65 mm (0,025 in)		

ENVASE PACKING	CANTIDAD QUANTITY	UNIDAD VENTA INNER BOX
00	1 Kg	1
01	500 Gr	2
02	250 Gr	4
03	100 Gr	10
16	200 U.	20
21	500 Gr	4
09 / 14	250 Gr	4
07 / 08	50 Gr	20
98	50 Gr	20
06	25 Gr	40

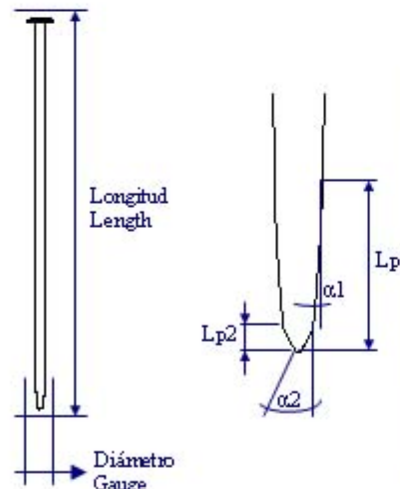

CAJA PLÁSTICO 25 G. **06**
PLASTIC BOX 25 G.



All straight pins are available in 1/2 lb. And 1 lb. boxes

No todos los alfileres están disponibles en todas las presentaciones. Consulta con nuestro departamento comercial.

info@folch.com / tel. 34-977826196 / fax 34-977826489

www.straightpins.com

























ALFILERES DE HIERRO / MILD STEEL PINS

FE

Ideales para escaparates, floristerías, decoración, modelismo y manualidades.

For office use, handicrafts, florists, decoration, school crafts and scale model.

REFERENCIA CODE	Nº	LONGITUD LENGTH	DIÁMETRO GAUGE	ENVASE BOX	CÓDIGO CODE
Ilustración a escala Illustration on scale				CARTÓN 1 KG CARDBOARD BOX 1 KG	00
ACABADO SURFACE ↓  AFN0365	000	10 mm (0,39 in)	0,65 mm (0,025 in)		
 AFN1080	000	10 mm (0,39 in)	0,80 mm (0,031 in)		
 AFN0465	4	16 mm (5/8")	0,65 mm (0,025 in)	CARTÓN 500 G CARDBOARD BOX 500 G	01
 AFN1865	4 1/2	18 mm (0,70 in)	0,65 mm (0,025 in)		
 AFN0870	8	20 mm (4/5")	0,70 mm (0,027 in)		
 AFN1470	14	26 mm (1-1/32")	0,70 mm (0,027 in)		
 AFN1565	15	27 mm (1-1/16")	0,65 mm (0,025 in)	CARTÓN 250 G CARDBOARD BOX 250 G	02
 AFN1670	16	28 mm (1-1/8")	0,70 mm (0,027 in)		
 AFN1880	18	30 mm (1-1/5")	0,80 mm (0,031 in)		
 AFN1890	18	30 mm (1-1/5")	0,90 mm (0,035 in)		
 AFN2270	22	32 mm (1-1/4")	0,70 mm (0,027 in)	PLÁSTICO 250 G PLASTIC BOX 250 G	96
 AFN2290	22	32 mm (1-1/4")	0,90 mm (0,035 in)		
 AFN2670	26	34 mm (1-1/3")	0,70 mm (0,027 in)		
 AFN2690	26	34 mm (1-1/3")	0,90 mm (0,035 in)		
 AFN3090	30	36 mm (1,41 in)	0,90 mm (0,035 in)	CAJA PLÁSTICO 50 G PLASTIC BOX 50 G	05
 AFN3211	32	38 mm (1-1/2")	1,10 mm (0,043 in)		
 ESF3211	3	42 mm (1-2/3")	1,10 mm (0,043 in)		
 ESF5120	5	50 mm (2")	1,20 mm (0,047 in)		

All straight pins are available in 1/2 lb. And 1 lb. boxes

ENVASE PACKING	CANTIDAD QUANTITY	UNIDAD VENTA INNER BOX
00	1 Kg	1
01	500 Gr	2
02	250 Gr	4
96	250 Gr	4
98	50 Gr	20
12	1/2 lbs	10
10	1 lbs	5

ACABADOS DISPONIBLES / FINISH AVAILABLES

N	NIQUELADO	NICKEL PLATED
D	DORADO	GILT
B	NEGRO	BLACK

No todos los alfileres están disponibles en todas las presentaciones. Consulta con nuestro departamento comercial.





info@folch.com / tel. 34-977826196 / fax 34-977826489

www.alfileres.com



PORTAPRECIOS / TICKET PINS

PP

Ilustración a escala Illustration on scale	REFERENCIA CODE	ACABADO SURFACE	LONGITUD LENGTH	ENVASE BOX	CÓDIGO CODE
	PPF4508	NIQUEL NICKEL PLATED	45 mm (1-3/4")	CARTÓN 5000 U. CARDBOARD BOX 5000 U.	22
	ATN3810	NIQUEL NICKEL PLATED	38 mm (1-1/2")	CARTÓN 200 U. CARDBOARD BOX 200 U.	46
T-pins for the apparel and arts and crafts industries.				PLÁSTICO 100 U. PLASTIC BOX 100 U.	05
	PBF3070	NIQUEL NICKEL PLATED	30 mm (1-1/5")		
Special quilt machine					

MACASARES / LOOSE COVER PINS

MA

Ilustración a escala Illustration on scale	REFERENCIA CODE	ACABADO SURFACE	LONGITUD LENGTH	ENVASE BOX	CÓDIGO CODE
	ALIKN	NIQUEL NICKEL PLATED	33 mm (1-1/3")	CARTÓN 200 U. CARDBOARD BOX 200 U.	46
LATÓN / BRASS				40 c/pl 36 U.	47
	ALIKD	DORADO GILT	33 mm (1-1/3")		
LATÓN / BRASS				PLÁSTICO 36 U. PLASTIC BOX 36 U.	05
Crimped pins that securely fasten slipcovers, tidies, dollies and arm caps in place. Rust resistant.					
					

www.folch.com / tel. 34-977826196 / fax 34-977826489















info@folch.com

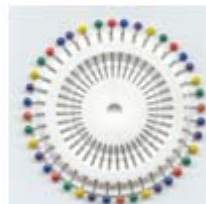

ALFILERES CABEZA DE COLORES / COLOUR HEAD PINS



Ideales para patchwork y quilting / For patchwork and quilting

	REFERENCIA CODE	HEAD	LONGITUD LENGTH	DIÁMETRO GAUGE	ENVASE BOX	CÓDIGO CODE
Ilustración a escala Illustration on scale					PLÁSTICO 40 U. PLASTIC BOX 40 U.	11
	ACV3060	V	30 mm (1-1/5")	0,60 mm (0,023 in)		
	AIC3259	PL	32 mm (1-1/4")	0,59 mm (0,023 in)		
	AAC3465	PL	34 mm (1-1/3")	0,65 mm (0,025 in)	PLÁSTICO 100 U. PLASTIC BOX 100 U.	29
	ACP3458	P	34 mm (1-1/3")	0,58 mm (0,022 in)		
	ACV3870	V	38 mm (1-1/2")	0,70 mm (0,027 in)		
	ACP4058	P	40 mm (1,57 in)	0,58 mm (0,022 in)		40 pins
	AAC4865	PL	48 mm (1-7/8")	0,65 mm (0,025 in)		
	ACV4978	V	49 mm (1,92 in)	0,78 mm (0,030 in)		
	AFA5060	PL	50 mm (2")	0,60 mm (0,023 in)		
	ALA5575	P	55 mm (2-1/6")	0,75 mm (0,029 in)		
	ACA5575	PL	55 mm (2-1/6")	0,80 mm (0,031 in)		
	AEA6280	PL	62 mm (2-3/7")	0,80 mm (0,031 in)	BOLSITAS 100 u BAGS 50 u	pinbag 007 pinbag 008

Glass heads resistant to ironing.

CABEZA / HEAD

PL → PLÁSTICO / PLASTIC

V → VIDRIO / GLASS

P → PERLA / PEARL

COLORES DISPONIBLES / AVAILABLE COLOURS



COLORES DISPONIBLES PERLA / AVAILABLE COLOURS PEARL HEAD



No todos los alfileres están disponibles en todas las presentaciones. Consulta con nuestro departamento comercial.

PLÁSTICO 100 U.
PLASTIC BOX 100 U.

05



All straight pins are available in 1/2 lb. And 1 lb. boxes

info@folch.com / tel. 34-977826196 / fax 34-977826489

www.straightpins.com



ALFILERES DE SEÑALIZACIÓN / MAP PINS

SE

Ilustración a escala Illustration on scale	REFERENCIA CODE	HEAD Ø	LONGITUD LENGTH	DIÁMETRO GAUGE	ENVASE BOX	CÓDIGO CODE		
	● AIC1259 (STAINLESS S.)	4 mm (0,16 in)	12 mm (1/2 ")	0,59 mm (0,023 in)	PLÁSTICO 100 U. PLASTIC BOX 100 U.	05		
	● AIC1459 (STAINLESS S.)	4 mm (0,16 in)	14 mm (0,55 in)	0,59 mm (0,023 in)				
	AIC1870 (STAINLESS S.)	4,5 mm (0,18 in)	18 mm (0,70 in)	0,70 mm (0,027 in)				
	AAC1860 (STEEL)	5 mm (1/5 ")	18 mm (0,70 in)	0,60 mm (0,023 in)				
	● AAC1865 (STEEL)	4 mm (0,16 in)	18 mm (0,70 in)	0,65 mm (0,025 in)				
	AAC2860 (STEEL)	7,5 mm (0,29 in)	28 mm (1-1/8 ")	0,60 mm (0,023 in)				
COLORES DISPONIBLES / AVAILABLE COLOURS ● ON ITEMS						PLÁSTICO 50 U. PLASTIC BOX 50 U.	50	
ROJO RED	VERDE GREEN	NEGRO BLACK	AZUL BLUE	LILA LILAC	AMARILLO YELLOW	GRANATE BURGUNDY	NARANJA ORANGE	AZUL CIELO SKYBLUE
01	02	03	04	05	06	07	08	09

ALFILERES SEÑALIZACIÓN / MAP PINS FLAGS

SE

Ilustración a escala Illustration on scale	REFERENCIA CODE	LONGITUD LENGTH	DIÁMETRO GAUGE	ENVASE BOX	CÓDIGO CODE
	AIF3259	32 mm (1-1/4 ")	0,59 mm (0,023 in)	PLÁSTICO 25 U. PLASTIC BOX 25 U.	05
	AIB3259	32 mm (1-1/4 ")	0,59 mm (0,023 in)		

ALFILERES PARA CORCHO / PUSH PINS

SE

Ilustración a escala Illustration on scale	REFERENCIA CODE	HEAD Ø	LONGITUD LENGTH	DIÁMETRO GAUGE	ENVASE BOX	CÓDIGO CODE
	APC2312	9 x 12 mm	23 mm (7/8 ")	1,12 mm (0,044 in)	PLÁSTICO 25 U. PLASTIC BOX 25 U.	05
	APM2312	9 x 12 mm	23 mm (7/8 ")	1,20 mm (0,047 in)		
For home, office and school.						
COLORES DISPONIBLES / AVAILABLE COLOURS						
ROJO RED	VERDE GREEN	NEGRO BLACK	AZUL BLUE	AMARILLO YELLOW	BLANCO WHITE	
01	02	03	04	05	06	

info@folch.com / tel. 34-977826196 / fax 34-977826489

www.alfileres.com



IMPERDIBLES ESPECIALES / MARKING PINS

IM

Marking pins are used for easy identification on items such as locker ID's, swim badges, key holders or as sock pins...

Ilustración a escala Illustration on scale	REFERENCIA CODE	ACABADO SURFACE	LONGITUD LENGTH	ENVASE BOX	CÓDIGO CODE
 Ideales para vestuarios de gimnasios, salones, etc.	IMPLAUNDRY	NIQUEL (NICKEL)	50 mm (2")	PLÁSTICO 36 U. PLASTIC BOX 36 U.	05
 Especiales para patchwork. Special for patchwork.	IMP CURV LATÓN/BRASS	NIQUEL (NICKEL)	38 mm (1-1/2 ")		



Printed both sides

IMPERDIBLE + BANDERA SAFETY PIN + FLAG





ARTÍCULOS PARA MANUALIDADES ESCOLARES / SCHOOL CRAFTS ARTICLES

ES

Fabricados sin punta para impedir que se claven.

Specially formed blunt points to prevent skin penetration.

Ilustración a escala Illustration on scale	REFERENCIA CODE	ACABADO SURFACE	Nº	LONGITUD LENGTH	ENVASE BOX	CÓDIGO CODE
Sin níquel Nickel free 	IP CHIL0127	ZINC (ZINC)	0	27 mm (1-1/16")	PLÁSTICO 100 U. PLASTIC BOX 100 U.	05
	ANEN1865	NIQUEL (NICKEL)	18	18 mm (0,70 in)		
	APLBL1499	PLÁSTICO (PLASTIC)	64	64 mm (2-1/2 ")		

info@folch.com / tel. 34-977826196 / fax 34-977826489

www.imperdibles.com











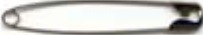

IMPERDIBLES NIQUELADOS / NICKEL PLATED SAFETY PINS

IM

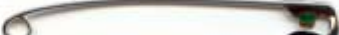
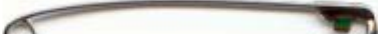
Creados para infinidad de aplicaciones, en el hogar, confección, medicina, lavanderías ...

Created for endless purpose at home, in manufacture, medicals, laundry ...







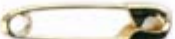

	REFERENCIA CODE	Nº	LONGITUD LENGTH	ENVASE BOX	CÓDIGO CODE
Ilustración a escala Illustration on scale				CARTÓN 10000 U. CARDBOARD BOX 10000 U.	23
 Ø alambre / wire 0,65 mm (0,025 in)	IPN0319	3/0	19 mm (3/4 ")	C/PLASTICO 1 GRUESA O 1/2 PLASTIC BOX 1 GROSS	36
 Ø alambre / wire 0,65 mm (0,025 in)	IPN0223	2/0	23 mm (7/8 ")	 MAZOS BUNCHES	
 Ø alambre / wire 0,75 mm (0,029 in)	IPN0127	0	27 mm (1-1/16 ")	C/PLASTICO 500-350-250 U. PLASTIC BOX 500-350-250 U.	09
 Ø alambre / wire 0,75 mm (0,029 in)	IPN1034	1	34 mm (1-1/3 ")	 SUELTOS LOOSE	
 Ø alambre / wire 0,85 mm (0,033 in)	IPN2038	2	38 mm (1-1/2 ")		
 Ø alambre / wire 1,00 mm (0,039 in)	IPN3045	3	45 mm (1-3/4 ")	C/PLASTICO 85 U. PLASTIC BOX 85 U.	85
 Ø alambre / wire 1,00 mm (0,039 in)	IPN4050	4	50 mm (2 ")		
 Ø alambre / wire 1,00 mm (0,039 in)	IPN5057	5	57 mm (2-1/4 ")		
 Ø alambre / wire 1,20 mm (0,047 in)	IPN8078	8	78 mm (3-1/16 ")	BOLSA PLASTICO 25 U. N° 0-00-000 PLASTIC BAG 25 U. N° 0-00-000	
					

info@folch.com / tel. 34-977826196 / fax 34-977826489

www.imperdibles.com



IMPERDIBLES DORADOS Y NEGROS / BRASS FINISH AND BLACK SAFETY PINS IM



	REFERENCIA CODE	Nº	LONGITUD LENGTH	ENVASE BOX	CÓDIGO CODE
Ilustración a escala Illustration on scale				CARTÓN 10000 U. CARDBOARD BOX 10000 U.	23
	IPD0319	3/0	19 mm (3/4 ")		
	IPD0223	2/0	23 mm (7/8 ")	PLÁSTICO 85 U. PLASTIC BOX 85 U.	85
	IPD0127	0	27 mm (1-1/16 ")		
	IPB0319	3/0	19 mm (3/4 ")	CARTÓN 20 GRUESAS CARDBOARD BOX 20 GROSS	34
	IPB0223	2/0	23 mm (7/8 ")		
	IPB0127	0	27 mm (1-1/16 ")	PLÁSTICO 1 GRUESA PLASTIC BOX 1 GROSS	34
					

Ideales para sujetar dorsales en cualquier competición: de atletismo, patinaje, baile, etc.

Perfect for holding on bib numbers in any kind of competition: athletics, skating, dance contest ...

PUAS DE HIERRO / MILD STEEL STEMS

PU

	REFERENCIA CODE	LONGITUD LENGTH	DIÁMETRO GAUGE	ENVASE BOX
Ilustración a escala Illustration on scale				
	PUA55	50 mm (2 ")	0,90 mm (0,035 in)	A GRANEL IN BULK
	PUA88	80 mm (3-1/6 ")	1,20 mm (0,047 in)	

info@folch.com / tel. 34-977826196 / fax 34-977826489

www.imperdibles.com



ALFILERES PARA CAMISAS / SHIRT PINS

CA

ALFILERES DE LATÓN / BRASS PINS

Ilustración a escala Illustration on scale	REFERENCIA CODE	Nº	LONGITUD LENGTH	DIÁMETRO GAUGE
	ALN1565	1 1/2	22 mm (7/8 ")	0,65 mm (0,025 in)
	ALN2070	2	24 mm (0,94 in)	0,70 mm (0,027 in)
	ALN2065	2	24 mm (0,94 in)	0,65 mm (0,025 in)
	ALN2570	2 1/2	26 mm (1-1/32 ")	0,70 mm (0,027 in)
	ALN2568	2 1/2	26 mm (1-1/32 ")	0,68 mm (0,026 in)
	ALN2565	2 1/2	26 mm (1-1/32 ")	0,65 mm (0,025 in)

ALFILERES DE LATÓN NIQUELADO

Para camisas de tela ligera y mediana, alfiler duro ideal, para sujetar la camisa al cartón de la armadura. Resistente a la corrosión en telas con residuos de cloro.

TEMPERATURA	INFERIOR 50°	ENTRE 60 Y 100°	ENTRE 100 Y 150°
Resistencia máxima en tejidos por residuos de cloro.	200 ppm iones cl	30 ppm iones cl	5 ppm

ALFILERES DE ACERO INOXIDABLE / STAINLESS STEEL PINS

Ilustración a escala Illustration on scale	REFERENCIA CODE	Nº	LONGITUD LENGTH	DIÁMETRO GAUGE
	AIN2259	22	22 mm (7/8 ")	0,59 mm (0,023 in)
	AIN2659	26	26 mm (1-1/32 ")	0,59 mm (0,023 in)

ALFILERES CABEZA DE PERA / DIPPED HEAD PINS

Ilustración a escala Illustration on scale	REFERENCIA CODE	Nº	LONGITUD LENGTH	DIÁMETRO GAUGE
	AIP2653	26	26 mm (1-1/32 ")	0,53 mm (0,020 in)
	AIP2659	26	26 mm (1-1/32 ")	0,59 mm (0,023 in)

COLORES DISPONIBLES / AVAILABLE COLOURS



ALFILERES DE ACERO INOXIDABLE

Para camisas de seda y de la más alta calidad en algodón y en algodón poliéster, alfileres con la más alta resistencia a la corrosión, su inoxidableidad y el brillo es de por vida. Ideales para camiseros ubicados en zonas húmedas, cerca del mar y con veranos muy calurosos.

CALIDAD ALAMBRE	TEMPERATURA	INFERIOR 50°	ENTRE 60 Y 100°	ENTRE 100 Y 150°
AISI 304	Resistencia máxima en tejidos por residuos de cloro.	200 ppm iones cl	30 ppm iones cl	5 ppm iones cl
AISI 316		2000 ppm iones cl	100 ppm iones cl	12 ppm iones cl



ALFILERES DE LATÓN / BRASS PINS

LL

Ilustración a escala Illustration on scale	REFERENCIA CODE	Nº	LONGITUD LENGTH	DIÁMETRO GAUGE	ENVASE BOX	CÓDIGO CODE
	ACABADO SURFACE ↓					
	ALN1080	000	10 mm (0,39 in)	0,80 mm (0,031 in)	CARTÓN 1 KG CARDBOARD BOX 1 KG	00
	ALN0360	000	10 mm (0,39 in)	0,60 mm (0,023 in)		
	ALN1260		12 mm (1/2 ")	0,60 mm (0,023 in)		
	ALN0260	00	14 mm (0,55 in)	0,60 mm (0,023 in)		
	ALN0163	0	16 mm (5/8 ")	0,63 mm (0,024 in)		
	ALN0565	1/2	18 mm (0,70 in)	0,65 mm (0,025 in)		
	ALN1070	1	20 mm (4/5 ")	0,70 mm (0,027 in)	CARTÓN 500 G CARDBOARD BOX 500 G	01
	ALN1065	1	20 mm (4/5 ")	0,65 mm (0,025 in)		
	ALN1570	1 1/2	22 mm (7/8 ")	0,70 mm (0,027 in)		
	ALN1565	1 1/2	22 mm (7/8 ")	0,65 mm (0,025 in)		
	ALN2070	2	24 mm (0,94 in)	0,70 mm (0,027 in)	CARTÓN 250 G CARDBOARD BOX 250 G	02
	ALN2065	2	24 mm (0,94 in)	0,65 mm (0,025 in)		
	ALN2570	2 1/2	26 mm (1-1/32 ")	0,70 mm (0,027 in)		
	ALN2568	2 1/2	26 mm (1-1/32 ")	0,68 mm (0,026 in)		
	ALN2565	2 1/2	26 mm (1-1/32 ")	0,65 mm (0,025 in)		
	ALN3075	3	28 mm (1-1/8 ")	0,75 mm (0,029 in)	PLÁSTICO 400 U. PLASTIC BOX 400 U.	05
	ALN4080	4	30 mm (1-1/5 ")	0,80 mm (0,031 in)		
	ALN5080	5	32 mm (1-1/4 ")	0,80 mm (0,031 in)		
	ALN6090	6	34 mm (1-1/3 ")	0,90 mm (0,035 in)		
	ALN7090	7	36 mm (1,41 in)	0,90 mm (0,035 in)		
	ALN8010	8	38 mm (1-1/2 ")	1,00 mm (0,039 in)		
	ALN1010	10	42 mm (1-2/3 ")	1,00 mm (0,039 in)		

ENVASE PACKING	CANTIDAD QUANTITY	UNIDAD VENTA INNER BOX
00	1 Kg	1
01	500 Gr	2
02	250 Gr	4
12	1/2 lbs	10
10	1 lbs	5

ACABADOS DISPONIBLES / FINISH AVAILABLES

N	NIQUELADO	NICKEL PLATED
P	PULIDO	POLISHED
D	DORADO	GILT

No todos los alfileres están disponibles en todas las presentaciones. Consulta con nuestro departamento comercial.

info@folch.com / tel. 34-977826196 / fax 34-977826489

www.alfileres.com

All straight pins are available in 1/2 lb. And 1 lb. boxes













ALFILERES DE ACERO INOXIDABLE / STAINLESS STEEL PINS

AI

Alfileres con la mas alta resistencia a la corrosión, de alta resistencia mecánica, inoxidabilidad y brillo.









INOX 304 : chromonic grade 304 — INOX 316 : momonic grade 316

Ilustración a escala Illustration on scale	REFERENCIA CODE	N°	LONGITUD LENGTH	DIÁMETRO GAUGE	ENVASE BOX	CÓDIGO CODE
 INOX. 304	AIN1852	18	18 mm (0,70 in)	0,52 mm (0,020 in)	 CARTÓN 1 KG CARDBOARD BOX 1 KG	00
 INOX. 304	AIN2059	22	22 mm (7/8 ")	0,59 mm (0,023 in)		
 INOX. 304	AIN2259	22	22 mm (7/8 ")	0,59 mm (0,023 in)		
 INOX. 304	AIN2659	26	26 mm (1-1/32 ")	0,59 mm (0,023 in)		
 INOX. 316	AIX2659	26	26 mm (1-1/32 ")	0,59 mm (0,023 in)		
 INOX. 304	AIN2649	26	26 mm (1-1/32 ")	0,49 mm (0,019 in)		
 INOX. 304	AIN3059	30	30 mm (1-1/5 ")	0,59 mm (0,023 in)	 CARTÓN 10000 U. CARDBOARD BOX 10000 U.	23
 INOX. 304	AIN3452	34	34 mm (1-1/3 ")	0,52 mm (0,020 in)		
 INOX. 304	AIN3859	38	38 mm (1-1/2 ")	0,59 mm (0,023 in)		

ALFILERES CABEZA DE PERA / DIPPED HEAD PINS

AP

Dipped head pins have a larger head for easy handling, thanks to our special polishing our pins penetrate smoothly and pierce fabrics easily.

	REFERENCIA CODE	N°	LONGITUD LENGTH	DIÁMETRO GAUGE	ENVASE BOX	CÓDIGO CODE
Ilustración a escala Illustration on scale					CARTÓN 5000 U. CARDBOARD BOX 5000 U.	22
 AIP2659 (PLATEADO)		26	26 mm (1-1/32 ")	0,59 mm (0,023 in)		
 AIP2654 (PLATEADO)		26	26 mm (1-1/32 ")	0,54 mm (0,021 in)		
 APA2654 (AZUL)		26	26 mm (1-1/32 ")	0,54 mm (0,021 in)		24
 APR2654 (ROJO)		26	26 mm (1-1/32 ")	0,54 mm (0,021 in)		
 APV2654 (VERDE)		26	26 mm (1-1/32 ")	0,54 mm (0,021 in)		
 APB2654 (BLANCO)		26	26 mm (1-1/32 ")	0,54 mm (0,021 in)	PLÁSTICO 400 U. PLASTIC BOX 400 U.	05

COLORES DISPONIBLES / AVAILABLE COLOURS

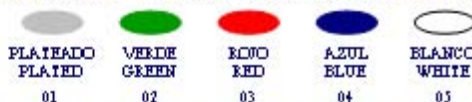

info@folch.com / tel. 34-977826196 / fax 34-977826489

www.straightpins.com



CLIPS CAMISEROS / CROSS OVER SHIRT CLIPS

CM

Ilustración a escala Illustration on scale	REFERENCIA CODE	MATERIAL	LONGITUD LENGTH	DIÁMETRO GAUGE	ENVASE BOX	CÓDIGO CODE
	CP C200	LATÓN / BRASS	32 mm (1-1/4")	1,10 mm (0,043 in)	CARTÓN 2000 U. CARDBOARD BOX 2000 U.	200
	CPX200	INOXIDABLE (STAINLESS STEEL)	32 mm (1-1/4")	1,10 mm (0,043 in)		
	CANON200 PLANO / PLAIN	LATÓN / BRASS	32 mm (1-1/4")	1,20 mm (0,047 in)		
	CPL200 PLANO / PLAIN (SAN JORGE)	LATÓN / BRASS	32 mm (1-1/4")	1,20 mm (0,047 in)	CARTÓN 3000 U. CARDBOARD BOX 3000 U.	3000
	CVALUABLE	LATÓN / BRASS	32 mm (1-1/4")	1,20 mm (0,047 in)		
	CP C263000	LATÓN / BRASS	26 mm (1-1/32")	1,10 mm (0,043 in)		
	CPA200	ALEACIÓN ALLOY	32 mm (1-1/4")	1,20 mm (0,047 in)		
	CANOA200 PLANO / PLAIN	ALEACIÓN ALLOY	32 mm (1-1/4")	1,20 mm (0,047 in)		
	CPACOL200 COLOR / COLOUR	ALEACIÓN ALLOY	32 mm (1-1/4")	1,20 mm (0,047 in)		
	C01					
	C02					
	C03					
	C04					
	C05					



CLIPS CAMISEROS

Clips que le realzarán el acabado de su camisa de calidad.

No dejan marca ni agujero en la camisa, puntas perfectamente redondeadas, alta elasticidad para permitir su fácil colocación. Dependiendo del grosor del tejido disponemos de clips con diferente presión, para optimizar la sujeción de la camisa. Alta resistencia a la corrosión en los acabados niquelados y máxima con el acero inoxidable.

www.folch.com / tel. 34-977826196 / fax 34-977826489

info@folch.com



CLIPS PERSONALIZADOS / PERSONALIZED CLIPS

CM

Ilustración a escala Illustration on scale	MATERIAL	LONGITUD LENGTH	DIÁMETRO GAUGE	ENVASE BOX	CÓDIGO CODE
	LATÓN / BRASS	32 mm (1-1/4")	1,20 mm (0,047 in)	CARTÓN 2000 U. CARDBOARD BOX 2000 U.	200

PROMOCIONE SU MARCA

Personalice los clips con su marca favorita.
 Distinga su camisa con clips personalizados.
 Máximo once letras por palabra, puede grabar 2 palabras diferentes.

Patentado en España.



personalized clips

Use them first for shirt packing and after they will promote your business.

Quality brass nickel plated clips embossed with your logo,

if you are looking for a cost-effective way of saying "thank-you" to your valued customers or, you're searching for a way to keep your name in front of that customer (for future sales and valuable referrals) ... then you should consider *personalized clips*.

Promote your business with promotional logo clips.

If you're looking for business gifts, give-aways, advertising, promotional items, then *personalized clips* would be your choice.

Personalize up to 2 lines, 11 characters per line, 1 line per side, double-sided patented product.

Personalize and create your own embossed clips. Ideal for shirtmakers, laundries or for your advertising promotion.





www.folch.com / tel. 34-977826196 / fax 34-977826489

info@folch.com

**PINZAS PARA CAMISAS / PLASTIC SHIRT CLIPS**

SA

Ilustración a escala Illustration on scale	REFERENCIA CODE	Nº	LONGITUD LENGTH	ENVASE BOX	CÓDIGO CODE
Transparent plastic for holding together new or laundered shirts. 	PINPLAS	40	40 mm (1,57 in)	CARTÓN 10000 U. CARDBOARD BOX 10000 U.	23
	PINPL04	4	42 mm (1-2/3 ")	BOLSA PLÁSTICO 5000 U. PLASTIC BAG 5000 U.	22
	PINPL06	6	35 mm (1-1/3 ")		

PINZAS PARA PANTALÓN / PLASTIC TROUSERS CLIPS

SA

Ilustración a escala Illustration on scale	REFERENCIA CODE	Nº	LONGITUD LENGTH	ENVASE BOX	CÓDIGO CODE
	PINPANT23	5	60 mm (2-1/3 ")	CARTÓN 10000 U. CARDBOARD BOX 10000 U.	23

TIRAS CUELLO / COLLAR STRIP

SA

	REFERENCIA CODE	DIMENSIONES DIMENSIONS	ENVASE BOX
	TCS435	462 x 35 x 0,30 mm	2000 U.

PALOMILLAS / COLLAR SUPPORTS

SA

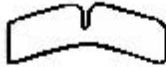
	REFERENCIA CODE	DIMENSIONES DIMENSIONS	ENVASE BOX
	PAL1344	103 mm x 22 mm x 0,25 mm	15000 U.

www.folch.com / tel. 34-977826196 / fax 34-977826489











info@folch.com



IMPERDIBLES DE COLORES / COLOURED SAFETY PINS

IM

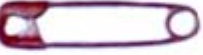
Ideales para crear pulseras, collares, etc. / For create bracelets, collars...

REFERENCIA CODE	Nº	LONGITUD LENGTH	ENVASE BOX	CÓDIGO CODE
Ilustración a escala Illustration on scale			CARTÓN 1000 U. CARDBOARD BOX 1000 U.	20
 IP CB0127 AZUL (BLUE)	0	27 mm (1-1/16 ")	PLÁSTICO 85 U. PLASTIC BOX 85 U.	85
 IP CC0127 CREMA (CREAM)	0	27 mm (1-1/16 ")		HOPSETCOL
 IP CF0127 FUCSIA (PINK)	0	27 mm (1-1/16 ")		
 IP CG0127 VERDE (GREEN)	0	27 mm (1-1/16 ")		EXIMPCOL
 IP CL0127 VIOLETA (LILAC)	0	27 mm (1-1/16 ")		
 IP CP0127 ROSA (PINK)	0	27 mm (1-1/16 ")		KIT01B
 IP CR0127 ROJO (RED)	0	27 mm (1-1/16 ")		
				

info@folch.com / tel. 34-977826196 / fax 34-977826489

www.imperdibles.com



IMPERDIBLES DE BEBE / NAPPY PINS

IM

Ilustración a escala Illustration on scale	REFERENCIA CODE	COLOR COLOUR	LONGITUD LENGTH	ENVASE BOX	CÓDIGO CODE
Cabeza de seguridad metálica Locking cap stainless steel shank				1 Posición de cierre de seguridad	
	IMPBEB	BLANCO (WHITE)	55 mm (2-1/6 ")		
	IMPBEP	ROSA (PINK)	55 mm (2-1/6 ")		
	IMPBL	AMARILLO (YELLOW)	55 mm (2-1/6 ")	PLÁSTICO 5 U. PLASTIC BOX 5 U.	05
	IMPBLU	AZUL (BLUE)	55 mm (2-1/6 ")		

Acero inoxidable, garantizamos alta resistencia a la corrosión. / Stainless steel, we guarantee the maximum corrosion resistance.

IMPERDIBLES PARA FALDA / KILT PINS

IF

Ilustración a escala Illustration on scale	REFERENCIA CODE	ACABADO SURFACE	LONGITUD LENGTH	ENVASE BOX	CÓDIGO CODE
	IFD1064	DORADO (BRASS FINISH)	64 mm (2-1/2 ")	CARTÓN 144 U. CARDBOARD BOX 144 U.	36
	IFD2076	DORADO (BRASS FINISH)	76 mm (3 ")	BLISTER 2 U.	BL2
	IFN1064	NIQUELADO (NICKEL)	64 mm (2-1/2 ")		
	IFN2076	NIQUELADO (NICKEL)	76 mm (3 ")		

info@folch.com / tel. 34-977826196 / fax 34-977826489

www.imperdibles.com



DEDALES / THIMBLES

DI

	REFERENCIA CODE	Nº	DIÁMETRO GAUGE	ENVASE BOX	CÓDIGO CODE
Ilustración a escala Illustration on scale				C/ CARTÓN 1 GRUESA CARDBOARD BOX 1 GROSS	36
	DIAL0219 (ALPACA/GERMAN SILVER) DIL0219 (LATÓN/BRASS)	3/0	18 mm (0,70 in)	1 UNIDAD CON PROBADOR 1 UNIT 	01
	DIAL0118 (ALPACA/GERMAN SILVER) DIL0118 (LATÓN/BRASS)	2/0	17 mm (2/3 ")	4 DOCENAS 4 DOZEN 	63
	DIAL1017 (ALPACA/GERMAN SILVER) DIL1017 (LATÓN/BRASS)	0	16 mm (5/8 ")		60
	DIAL2016 (ALPACA/GERMAN SILVER) DIL2016 (LATÓN/BRASS)	1	15 mm (3/5 ")	1 DOCENA 1 DOZEN 	LUX72U
	DIAL3015 (ALPACA/GERMAN SILVER) DIL3015 (LATÓN/BRASS)	2	14,2 mm (0,56 in)	EXPOSITOR 72 U. 	MLUX72U
	DIAL4014 (ALPACA/GERMAN SILVER) DIL4014 (LATÓN/BRASS)	3	13,6 mm (0,53 in)		

www.folch.com / tel. 34-977826196 / fax 34-977826489

info@folch.com



GANCHOS PARA CORTINA / CURTAIN HANGERS

GA

Ilustración a escala Illustration on scale	REFERENCIA CODE	LONGITUD LENGTH	ENVASE BOX	CÓDIGO CODE
Hierro / mild steel  Zincado / Zinc	GANFE20	45 mm (1-3/4")	PLÁSTICO 50 U. PLASTIC BOX 50 U. 	05



PORTAEMBLEMAS / BADGE PINS

EM

Ilustración a escala Illustration on scale	REFERENCIA CODE	TIPO TYPE	LONGITUD LENGTH	ENVASE BOX	CÓDIGO CODE
Latón / brass  Niquelado o dorado / nickel plated or gilt	APEZ20	Z-20	20 mm (4/5")	A GRANEL IN BULK	20
Latón / brass  Niquelado o dorado / nickel plated or gilt	APEZ30	Z-30	30 mm (1-1/5")		
 Zincado / zinc	APEZ32	Z-32	32 mm (1-1/4")		

CINTAS MÉTRICAS / TAPE MEASURES

CI

	REFERENCIA CODE	LONGITUD LENGTH	ENVASE BOX	CÓDIGO CODE
 PRINTED BOTH SIDES	CIN900160	150 mm	DOCENA CAJA PL REDONDA PLASTIC BOX 12 U.	60
	CIN900260	150 mm		
	CIN900360	150 mm		DOCENA CON PROTECCIÓN 12 U. WITH PROTECTION
			DOCENA CAJA CARTÓN CARDBOARD BOX 12 U.	60

Posibilidad de personalizar las cintas métricas. Pedido mínimo de 3000 cintas.



The tapes can be printed with your logo. Order minim 3000 u.

www.folch.com / tel. 34-977826196 / fax 34-977826489



info@folch.com

**ALFILETEROS / PIN CUSHION**



AL

REFERENCIA CODE	DESCRIPCIÓN DESCRIPTION	ENVASE BOX	CÓDIGO CODE
 PINPOOLS	Afiletero magnético Magnetic pin cushion	C/ CARTÓN BLISTER	PINPOOL
 ALFSU6060	Afiletero de tela Pin cushion	BLISTER	60

Fun, colourful and cute pin cushions



COSTUREROS / SEWING BASKETS

CS

REFERENCIA CODE	DESCRIPCIÓN DESCRIPTION	
COSF4314	ESTUCHE OCTOGONAL GIGANTE GIANT OCTOGONAL CASE	
COS4688	CAJAS VARIADAS VARIED BOXES	
COSC4421	COFRE GRANDE BIG COFFER	
COSC4420	COFRE MEDIANO HALF-FILLED COFFER	

AGUJAS MÁQUINA TALÓN PLANO / SEWING MACHINE NEEDLES FLATTENED SHANK
MC

	REFERENCIA CODE	Nº	LONGITUD LENGTH	Ø AGUJA Ø NEEDLE	ENVASE BOX	CÓDIGO CODE	
	AGB605	60	33,9 mm (1-1/3 ")	0,60 mm (0,023 in)	C/PLÁSTICO 5 U. PLASTIC BOX 5 U. 	05	
	AGB705	70	33,9 mm (1-1/3 ")	0,70 mm (0,027 in)			
	AGB805	80	33,9 mm (1-1/3 ")	0,80 mm (0,031 in)			
	AGB905	90	33,9 mm (1-1/3 ")	0,90 mm (0,035 in)			
	AGB1005	100	33,9 mm (1-1/3 ")	1 mm (0,039 in)			
	AGB1105	110	33,9 mm (1-1/3 ")	1,10 mm (0,043 in)			
	AGBS1	S	33,9 mm (1-1/3 ")	Nº 70-80-90 surtidos/assorted			
	AGBS2	S	33,9 mm (1-1/3 ")	Nº 70-80-90-100 surtidos/assorted			
	AGBJ905 JEANS	90	33,9 mm (1-1/3 ")	0,90 mm (0,035 in)			DISPENSADOR 20 CAJITAS 20 DISPENSER 20 BOXES
	AGBJ105 JEANS	100	33,9 mm (1-1/3 ")	1 mm (0,039 in)			
AGBJ1105 JEANS	110	33,9 mm (1-1/3 ")	1,10 mm (0,043 in)				
AGBS7505 STRETCH	75	33,9 mm (1-1/3 ")	0,75 mm (0,029 in)				
AGBS9005 STRETCH	90	33,9 mm (1-1/3 ")	0,90 mm (0,035 in)				
AGBQ7505 QUILTING	75	33,9 mm (1-1/3 ")	0,75 mm (0,029 in)				
AGBQ9005 QUILTING	90	33,9 mm (1-1/3 ")	0,90 mm (0,035 in)				
AGBE7505 EMBROIDERY	75	33,9 mm (1-1/3 ")	0,75 mm (0,029 in)				
AGBE9005 EMBROIDERY	90	33,9 mm (1-1/3 ")	0,90 mm (0,035 in)				
AGBFG7005 PUNTA BOLA	70	33,9 mm (1-1/3 ")	0,70 mm (0,027 in)				
AGBFG8005 PUNTA BOLA	80	33,9 mm (1-1/3 ")	0,80 mm (0,031 in)				
AGBFG9005 PUNTA BOLA	90	33,9 mm (1-1/3 ")	0,90 mm (0,035 in)				

AGUJAS MÁQUINA TALÓN REDONDO / SEWING MACHINE NEEDLES ROUND SHANK
MC

	REFERENCIA CODE	Nº	LONGITUD LENGTH	Ø CAÑA Ø SHANK	Ø AGUJA Ø NEEDLE	ENVASE BOX	CÓDIGO CODE
	AGBR810	80	33,9 mm (1-1/3 ")	2 mm (0,078 in)	0,80 mm (0,031 in)	C/PLÁSTICO 5 U. PLASTIC BOX 5 U. 	05
	AGBR910	90	33,9 mm (1-1/3 ")	2 mm (0,078 in)	0,90 mm (0,035 in)		
	AGBR10	100	33,9 mm (1-1/3 ")	2 mm (0,078 in)	1 mm (0,039 in)		
	AGBR11	110	33,9 mm (1-1/3 ")	2 mm (0,078 in)	1,10 mm (0,043 in)		

www.folch.com / tel. 34-977826196 / fax 34-977826489

info@folch.com



ALFILERES PARA DECORACIÓN / SEQUIN PINS





HC

Ilustración a escala Illustration on scale	REFERENCIA CODE	Nº	LONGITUD LENGTH	DIÁMETRO GAUGE	ENVASE BOX	CÓDIGO CODE
	AFN0365	000	10 mm (0,39 in)	0,65 mm (0,025 in)	PLÁSTICO 400 U. PLASTIC BOX 400 U. 	05
	ALD0360	000	10 mm (0,39 in)	0,60 mm (0,023 in)		
	AFN1465	14	14 mm (0,55 in)	0,65 mm (0,025 in)		
	ALD0163	0	16 mm (5/8 ")	0,63 mm (0,024 in)		
	AFN0465	4	16 mm (5/8 ")	0,65 mm (0,025 in)		
	AFN1865	18	18 mm (0,70 in)	0,65 mm (0,025 in)		
	AFN0870	8	20 mm (4/5 ")	0,70 mm (0,027 in)		
Sin punta Blunt point	ANEN1865	18	18 mm (0,70 in)	0,65 mm (0,025 in)		



FIGURAS DE POLIESPÁN / STYROFOAM FIGURES

HC

FIGURA FIGURE	
ESTRELLA / STAR	
BOLA / BALL	
GIRASOL / SUNFLOWER	
PERRO / DOG	
CAMPANA / BELL	

info@folch.com / tel. 34-977826196 / fax 34-977826489





























www.hobby-creative.com



ALFILERES PARA BOLILLOS / LACE PINS

BOL

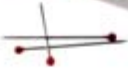
Estos alfileres son ideales para sujetar el patrón sobre la almohadilla / Straight pins are essential because they hold the pattern on the pillow

Ilustración a escala Illustration on scale	REFERENCIA CODE	Nº	LONGITUD LENGTH	DIÁMETRO GAUGE	ENVASE BOX	CÓDIGO CODE
 LATÓN DORADO / BRASS FINISH	ALD1865	1/2	18 mm (0,70 in)	0,65 mm (0,025 in)	C/PLÁSTICO 75 U. PLASTIC BOX 75 U.	27
 ACERO INOX. / STAINLESS STEEL	AIN1852	18	18 mm (0,70 in)	0,52 mm (0,020 in)		
 LATÓN DORADO / BRASS FINISH	ALD2565	2 1/2	26 mm (1-1/32")	0,65 mm (0,025 in)		
 LATÓN / BRASS	ALN2565	2 1/2	26 mm (1-1/32")	0,65 mm (0,025 in)		
 ACERO INOX. / STAINLESS STEEL	AIP2654	26	26 mm (1-1/32")	0,54 mm (0,021 in)		
 ACERO INOX. / STAINLESS STEEL	APA2654	26	26 mm (1-1/32")	0,54 mm (0,021 in)	C/PLÁSTICO 100 U. PLASTIC BOX 100 U.	29
 ACERO INOX. / STAINLESS STEEL	APB2654	26	26 mm (1-1/32")	0,54 mm (0,021 in)		
 ACERO INOX. / STAINLESS STEEL	APR2654	26	26 mm (1-1/32")	0,54 mm (0,021 in)		
 ACERO INOX. / STAINLESS STEEL	APV2654	26	26 mm (1-1/32")	0,54 mm (0,021 in)		
 ACERO INOX. / STAINLESS STEEL	APY2654	26	26 mm (1-1/32")	0,54 mm (0,021 in)		
 ACERO / HARD STEEL	AAN3050	6	30 mm (1-1/5")	0,50 mm (0,019 in)	C/PLÁSTICO 200 U. PLASTIC BOX 200 U.	32
 ACERO / HARD STEEL	AAN6060	6	30 mm (1-1/5")	0,60 mm (0,023 in)		
 ACERO / HARD STEEL	ACV3060	30	30 mm (1-1/5")	0,60 mm (0,023 in)		
 ACERO INOX. / STAINLESS STEEL	AIC3259	32	32 mm (1-1/4")	0,59 mm (0,023 in)		
 ACERO / HARD STEEL	AAN8060	8	34 mm (1-1/3")	0,60 mm (0,023 in)		
 ACERO INOX. / STAINLESS STEEL	AIN3452	34	34 mm (1-1/3")	0,52 mm (0,020 in)	C/PLÁSTICO 400 U. PLASTIC BOX 400 U.	25
 ACERO INOX. / STAINLESS STEEL	AIN3859	38	38 mm (1-1/2")	0,59 mm (0,023 in)		
 ACERO / HARD STEEL	ACV3870	38	38 mm (1-1/2")	0,70 mm (0,027 in)		
 LATÓN / BRASS	ALN4210	10	42 mm (1-2/3")	1,10 mm (0,043 in)		
 ACERO / HARD STEEL	AAN4565	45	45 mm (1-3/4")	0,65 mm (0,025 in)		
 ACERO / HARD STEEL	ACV4978	49	49 mm (1,92 in)	0,78 mm (0,030 in)		

info@folch.com / tel. 34-977826196 / fax 34-977826489

















www.lace-pins.com

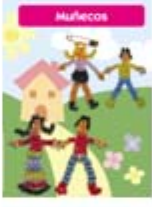

KITS DISEÑO DE FIGURAS / BEAD FIGURES

KI

Actividad creativa para fomentar habilidades, la imaginación, la destreza y el aprendizaje en la técnica de figuras de alambre en dos dimensiones.

REFERENCIA CODE	DESCRIPCIÓN DESCRIPTION	BLISTER SET	Hobby Creative
KITFIL01	 <p>Insectos terrestres</p>	<p>Crea 10 insectos Modelos: saltamontes, araña, hormiga, mariposa.</p> <p>Contiene alambre 25 m, rocalla, canutillo e imperdibles e instrucciones paso a paso.</p>	  <p>patentado</p>
KITFIL02	 <p>Insectos voladores</p>	<p>Crea 10 insectos Modelos: abeja, mariposa, mosca y libélula.</p> <p>Contiene alambre 25 m, rocalla, canutillo e imperdibles e instrucciones paso a paso.</p>	 
KITFIL03	 <p>Reptiles</p>	<p>Crea 10 reptiles Modelos: lagartija, cocodrilo, tortuga y dragón.</p> <p>Contiene alambre 25 m, rocalla, canutillo e imperdibles e instrucciones paso a paso.</p>	 
KITFIL04	 <p>Muñecos</p>	<p>Crea 10 muñecos Modelos: niños y niñas.</p> <p>Contiene alambre 25 m, rocalla, imperdibles e instrucciones paso a paso.</p>	 
KITFIL05	 <p>Navidad</p>	<p>Crea 5 adornos Modelos: Estrella, papa Noel, árbol, guirnalda, feliz navidad.</p> <p>Contiene alambre 25 m, rocalla, canutillos, imperdibles e instrucciones paso a paso.</p>	 
KITFIL06	 <p>Fútbol</p>	<p>Crea tu equipo de fútbol Modelos: portería y jugadores</p> <p>Contiene alambre 25 m, rocalla, canutillos, e instrucciones paso a paso.</p>	 

Blister packing

BEAD FIGURES CREATIVE SETS

Each category set contains everything that you need to make two dimensions (2D) creatures, all the material; glass beads, wire, safety pins, instructions step by step and designs... Finished creatures are lifelike, in proportion, and slightly poseable, excellent for kids aged more than eight years, beaders, and crazy quilters alike...





ALAMBRE COBRE DE COLORES / COLOURED WIRE

HI

Alambre de múltiples utilidades, ideal para decoración y figuras, animales, flores y también para bisutería.

Hobby Creative	REFERENCIA CODE	TIPO TYPE	LONGITUD LENGTH	DIÁMETRO GAUGE	ENVASE BOX	CÓDIGO CODE
	HLROJO (RED)	LISO (SMOOTH)	25 m	0,30 mm (0,011 in)		10
	HLAZUL (BLUE)	LISO (SMOOTH)	25 m	0,30 mm (0,011 in)		
	HLAPRICOT (APRICOT)	LISO (SMOOTH)	25 m	0,30 mm (0,011 in)		
	HLNEGRO (BLACK)	LISO (SMOOTH)	25 m	0,30 mm (0,011 in)		
	HLPLATA (SILVER)	LISO (SMOOTH)	25 m	0,30 mm (0,011 in)		
	HL COBRE (COPPER)	LISO (SMOOTH)	25 m	0,30 mm (0,011 in)		
	HL VERDE (GREEN)	LISO (SMOOTH)	25 m	0,30 mm (0,011 in)		
	HLORO (GOLD)	LISO (SMOOTH)	25 m	0,30 mm (0,011 in)		
	HEORO (GOLD)	ESTRIADO (BOUILLON)	25 G	0,25 mm (0,009 in)		
	HEAZUL (BLUE)	ESTRIADO (BOUILLON)	25 G	0,25 mm (0,009 in)		
	HEROJO (RED)	ESTRIADO (BOUILLON)	25 G	0,25 mm (0,009 in)		20
	HEPLATA (SILVER)	ESTRIADO (BOUILLON)	25 G	0,25 mm (0,009 in)		
	HEVERDE (GREEN)	ESTRIADO (BOUILLON)	25 G	0,25 mm (0,009 in)		
	HEAPRICOT (APRICOT)	ESTRIADO (BOUILLON)	25 G	0,25 mm (0,009 in)		
	HENARANJ (ORANGE)	ESTRIADO (BOUILLON)	25 G	0,25 mm (0,009 in)		

Bobinas con cierre / apertura.

Reels open / close feature.

C/ 20 BOBINAS
BOX 20 BOBBINS

ALFILERES PARA INSECTOS / INSECT PINS-ENTOMOLOGICAL PINS





IN

Ilustración a escala Illustration on scale	REFERENCIA CODE	LONGITUD LENGTH	DIÁMETRO GAUGE	ENVASE BOX	CÓDIGO CODE
	AIN3059	30 mm (1-1/5 ")	0,59 mm (0,023 in)		05
	AIN3452	34 mm (1-1/3 ")	0,52 mm (0,020 in)		
	AIN3852	38 mm (1-1/2 ")	0,52 mm (0,020 in)		
	AIN3859	38 mm (1-1/2 ")	0,59 mm (0,023 in)		







CÁNCAMOS / BRASS EYEBOLT

PE

Ilustración a escala Illustration on scale	REFERENCIA CODE	LONGITUD LENGTH	DIÁMETRO GAUGE	ENVASE BOX	CÓDIGO CODE
Ideales para modelismo. LATÓN /BRASS	 GLD0770	7 mm (0,27 in)	0,70 mm (0,027 in)	PLÁSTICO 100 U. PLASTIC BOX 100 U. 	05
	 GLD1070	10 mm (0,39 in)	0,70 mm (0,027 in)		
	 GLD1590	15 mm (3/5 ")	0,90 mm (0,035 in)		

GANCHOS / EYE PINS





PE

Ilustración a escala Illustration on scale	REFERENCIA CODE	LONGITUD LENGTH	DIÁMETRO GAUGE	ENVASE BOX	CÓDIGO CODE
LATÓN /BRASS				PLÁSTICO 50 U. PLASTIC BOX 50 U. 	05
 GLD6070	60 mm (2-1/3 ")	0,70 mm (0,027 in)			
DORADO / GILT	 GLP6070	60 mm (2-1/3 ")	0,70 mm (0,027 in)		
PLATA / SILVER	 GLPV6070	60 mm (2-1/3 ")	0,70 mm (0,027 in)		
PLATA VIEJA / OLD SILVER					

Ideales para diseñar pendientes.















ESPIGAS / HEAD PINS

PE

Ilustración a escala Illustration on scale	REFERENCIA CODE	LONGITUD LENGTH	DIÁMETRO GAUGE	ENVASE BOX	CÓDIGO CODE
LATÓN /BRASS				PLÁSTICO 50 U. PLASTIC BOX 50 U. 	05
 ELD3070	30 mm (1-1/5 ")	0,70 mm (0,027 in)			
 ELD4060	40 mm (1,57 in)	0,60 mm (0,023 in)			
 ELD5060	50 mm (2 ")	0,60 mm (0,023 in)			
 ELD6060	60 mm (2-1/3 ")	0,60 mm (0,023 in)			

CLAVOS PARA MARQUETERIA / BRASS ESCUTCHEON PINS

CL

CABEZA HEAD	PUNTA POINT	REFERENCIA CODE	LONGITUD LENGTH	DIÁMETRO GAUGE	ENVASE BOX	CÓDIGO CODE
		ALD0360	10 mm (0,39 in)	0,60 mm (0,023 in)	PLÁSTICO 100 U. PLASTIC BOX 100 U. 	05
		ALD1260	12 mm (3/6 ")	0,60 mm (0,023 in)		
		CLA1080	10 mm (0,39 in)	0,80 mm (0,031 in)		
		CLA1010	10 mm (0,39 in)	1 mm (0,039 in)		
		CLA1110	11 mm (3/7 ")	1 mm (0,039 in)		
		CLA1414	14 mm (4/7 ")	1,50 mm (0,059 in)		
		CLA1915	19 mm (3/4 ")	1,50 mm (0,059 in)		

Clavos de latón para marquetería y aplicaciones industriales.

Solid brass escutcheon pins are used in any project where small nails are required. They are ideal for craft projects. These solid brass nails will never rust making them perfect for outdoor applications. Used mainly in wood working.

info@folch.com

jabali pins

applique pins
bank pins
badge pins
beading pins
brass pins
bridal pins
brush pins
carpet pins
colour head pins
contact pins
common pins
corsage pins
craft pins
crimp pins
dipped head pins
drawing pins
dressmaking pins
entomological pins
eye pins
escutcheon pins
flag pins
florist pins
flower pins
glass headed pins
handicraft pins
hard steel pins
head pins
hobby pins
household pins
identification pins
insect pins
kilt pins
lace pins
laundry pins
loose cover pins
map pins
marking pins
model pins
mounting pins
nappy pins
net bag pins
office pins
paper pins
patchwork pins
pearlized pins
plastic head pins
pleating pins
push pins
quilting pins
racing pins
safety pins
satin pins
straight pins
sequin pins
shirt pins
silk pins
steel pins
stainless steel pins
tailor pins
taxidermy pins
ticket pins
T PINS
toilet pins
triangle pins
upholstery pins
z pins

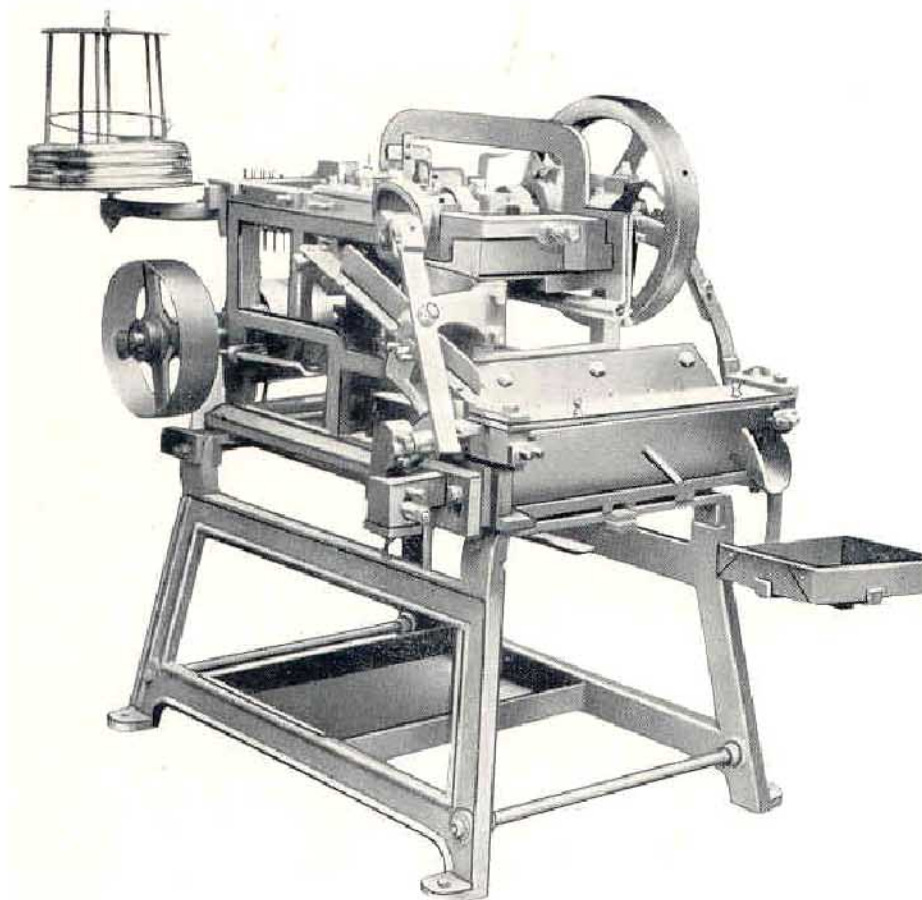

Máquina de alfileres utilizada desde 1924 al 1965
Pin making machine used from 1924 till 1965

Pin making is our family's heritage, our goal is to continue manufacturing pins with the old skills more efficiently and always be able to draw the line distinguishing between quality craftsmanship and mass production.

Our company aim is to keep the proud tradition as quality pin manufacturers with our european heritage, for future generations.

Josep M. Folch



made in Spain

Metalúrgica Folch S.L. Av. Sant Jordi, 6, 43340 Montbrió del Camp, Tarragona (Spain)
Tel. 34-977-826196 · Fax 34-977-826489 E-mail info@folch.com · <http://www.folch.com//>